

# 8 Cables

---

- [8.1 DC Power Cable \(OT and Cord End Terminals\)](#)
- [8.2 AC Power Cable](#)
- [8.3 Ground Cable](#)
- [8.4 Console Cable](#)
- [8.5 Clock Cable](#)
- [8.6 Ethernet Cable](#)
- [8.7 High-Speed Cable](#)
- [8.8 Optical Fiber](#)

## 8.1 DC Power Cable (OT and Cord End Terminals)

---

### NOTICE

Connectors and power capacity of a power cable must match the device on which the cable is used. Therefore, a device must use the power cables delivered with it.

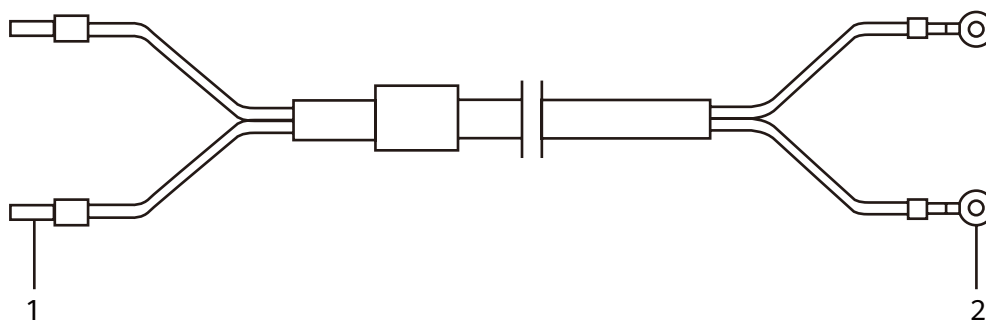
---

### Types of DC Power Cables

DC power cables of fixed lengths (integer number of meters) are delivered with switches. Cut the DC power cables into appropriate lengths based on actual situations in your site.

DC power cables include -48 V power cables and RTN ground cables. The lengths and terminal types of DC power cables used between power distribution boxes and power distribution frames are determined by the site survey results. DC power cables with OT terminals are connected to power modules, as shown in [Figure 8-1](#).

**Figure 8-1** DC power cable with an OT terminal



1. Cord end terminal	2. OT terminal
----------------------	----------------

## Connection

The cord end terminal is connected to a power distribution box or power distribution frame, and the OT terminal is connected to a 1600 W, 2200 W DC power module.

## 8.2 AC Power Cable

### NOTICE

Connectors and power capacity of a power cable must match the device on which the cable is used. Therefore, a device must use the power cables delivered with it.

### NOTE

If country-specific power cables are required, ensure that the power cables used on a device comply with standards of the destination country or region. This document uses the China-specific power cables as an example.

## Types of AC Power Cables

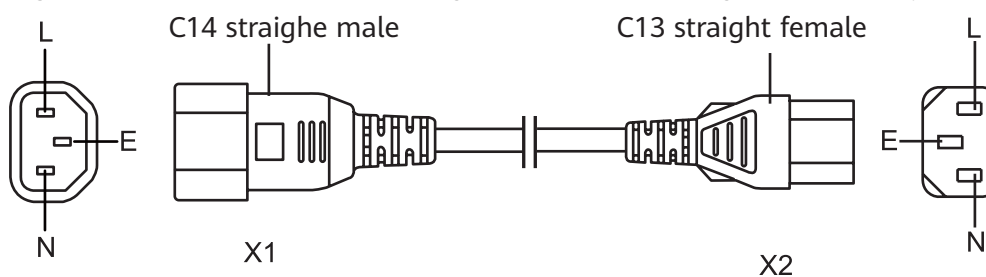
Select AC power cables based on the power supply system in your equipment room. The lengths and terminal types of AC power cables used between power distribution boxes and power distribution frames are determined by the site survey results. Standard and country-specific AC power cables can be directly connected to power modules.

- Standard power cables: used to transmit power from a PDU. **Figure 8-2** shows the structure of a C14 straight male to C13 straight female AC power cable, and **Figure 8-3** shows the structure of a C20 straight male to C19 straight female AC power cable.
- Country-specific power cables: used to transmit power from a country-specific power strip. The cables are delivered in compliance with standards of the destination country or region. For example, PI straight male to C13 straight

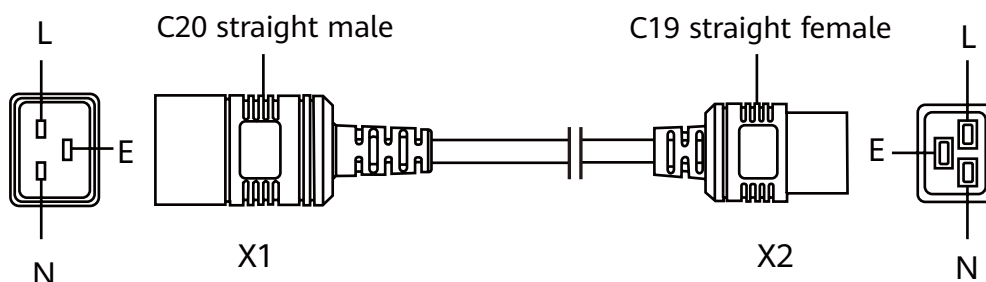
female AC power cables (Figure 8-4) and PI angle male to C19 straight female AC power cables (Figure 8-5) are used in China.

- The AC power cables connected to a power distribution box must have cord end terminals. Figure 8-6 shows the structure of a cord end to C13 straight female AC power cable. Figure 8-7 shows the structure of a cord end to C19 straight female AC power cable.

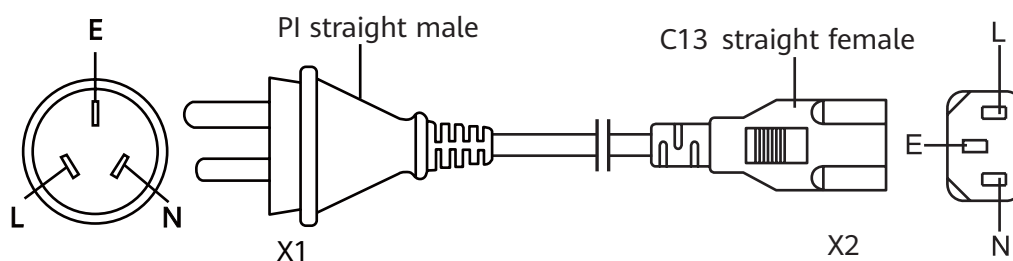
**Figure 8-2** Structure of a C14 straight male to C13 straight female AC power cable



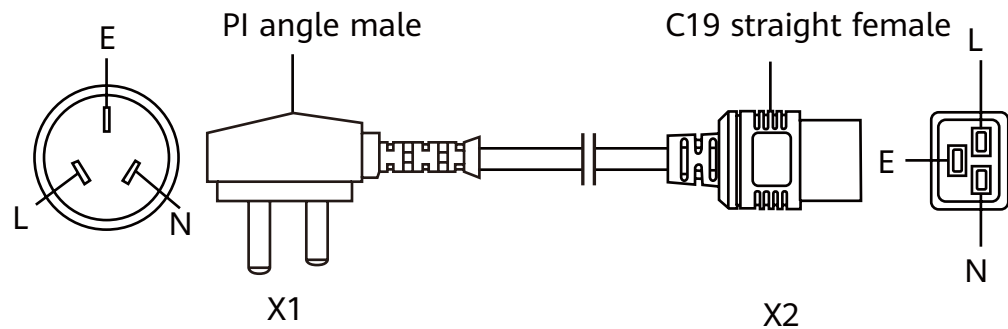
**Figure 8-3** Structure of a C20 straight male to C19 straight female AC power cable



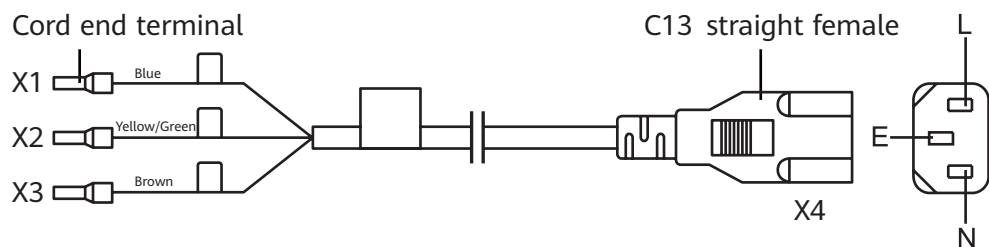
**Figure 8-4** Structure of a PI straight male to C13 straight female AC power cable (used in China)



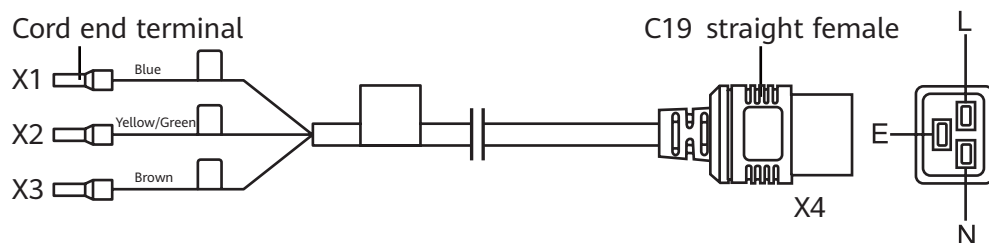
**Figure 8-5** Structure of a PI angle male to C19 straight female AC power cable (used in China)



**Figure 8-6** Structure of a Cord end to C13 straight female AC power cable (used in China)



**Figure 8-7** Structure of a Cord end to C19 straight female AC power cable (used in China)



## Connection

**Table 8-1** shows connections of various AC power cables.

**Table 8-1** Connections of AC power cables

Power Cable Type	Connector Type and Connection	
<b>C14 straight male to C13 straight female AC power cable</b>	C14 straight male connector: connected to a PDU	C13 straight female connector: connected to the power socket of an 800 W AC power module.
<b>PI straight male to C13 straight female AC power cable (used in China)</b>	PI straight male connector: connected to a country-specific power strip	The current rating of the power cable is 10 A.

Power Cable Type	Connector Type and Connection	
<b>Cord end to C13 straight female AC power cable (used in China)</b>	<p>Cord end terminal: connected to a power distribution box or power distribution frame.</p> <p>Connect the brown wire to the L terminal, blue wire to the N terminal, and the yellow/green wire to the ground terminal. Different AC power cables may be delivered in compliance with local regulations or customer requirements.</p>	
<b>C20 straight male to C19 straight female AC power cable</b>	C20 straight male connector: connected to a PDU	C19 straight female connector: connected to the power socket of a 2200 W AC or a 3000 W AC power module.
<b>PI angle male to C19 straight female AC power cable (used in China)</b>	PI angle male connector: connected to a country-specific power strip	The current rating of the power cable is 16 A.
<b>Cord end to C19 straight female AC power cable (used in China)</b>	<p>Cord end terminal: connected to a power distribution box or power distribution frame.</p> <p>Connect the brown wire to the L terminal, blue wire to the N terminal, and the yellow/green wire to the ground terminal. Different AC power cables may be delivered in compliance with local regulations or customer requirements.</p> <p>When the 3000 W AC power module uses 240 V high-voltage DC input, use the C19 straight female AC power cable.</p>	

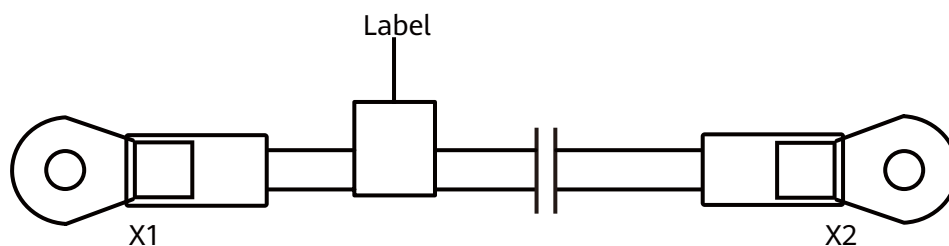
## 8.3 Ground Cable

### Appearance and Structure

Ground cables connect the chassis and cabinet to the ground. The ground cables are connected on the front door, rear door, and side panels of a cabinet before delivery.

**Figure 8-8** shows the structure of a ground cable.

**Figure 8-8** Structure of a ground cable



## Pin Assignments

**Table 8-2** lists the pin assignments of a ground cable.

**Table 8-2** Pin assignments of a ground cable

X1	X2	Wire Color	Conductor Cross-Sectional Area	Length
OT-6	OT-6	Green-yellow	6 mm <sup>2</sup>	1 m

## 8.4 Console Cable

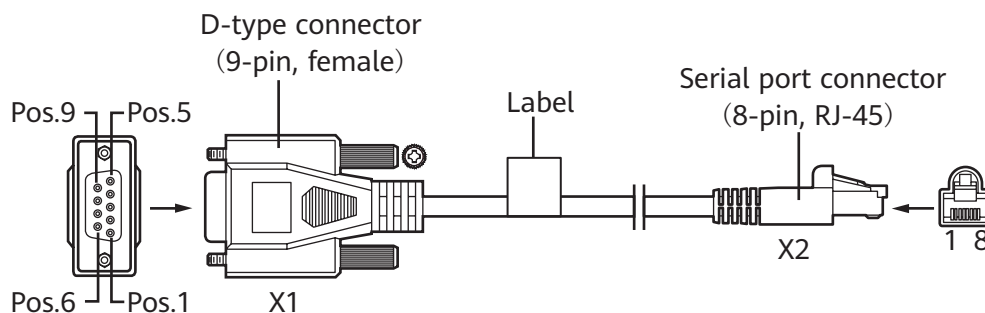
### Types of Console Cables

A console cable connects the switch console port to the serial port of a configuration terminal to transmit configuration data.

### Appearance and Structure

**Figure 8-9** shows the structure of a console cable.

**Figure 8-9** Structure of a console cable



## Pin Assignments

**Table 8-3** lists the pin assignments of console cable connectors.

**Table 8-3** Pin assignments of console cable connectors

Connector	X1 (DB9)	X2 (RJ45)
Pin assignment	2	3
	3	6
	5	5

## Connection

A console cable has an RJ45 connector on one end and a DB9 connector on the other end. The RJ45 connector is connected to the console port of the main processing unit, and the DB9 connector is connected to the serial port of a computer.

## 8.5 Clock Cable

### Introduction

The external clock ports of a switch are used for clock and time synchronization.

A clock cable connects a switch to an external clock source or a time source device.

When a switch connects to external devices through clock cables, it provides the following functions:

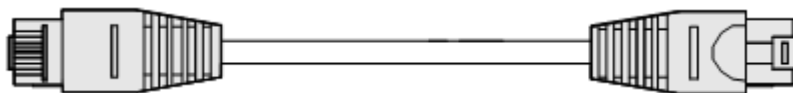
- Receives 2-channel 2.048 MHz or 2.048 Mbit/s clock signals from the upstream device and delivers 2-channel 2.048 MHz or 2.048 Mbit/s clock signals to the downstream device.
- Receives 2-channel ToD or DCLS time signals from the upstream device and delivers 2-channel ToD or DCLS time signals to the downstream device.

## Appearance and Structure

### RJ48 Cable

RJ48 cables applicable to the switch are 120-ohm trunk cables (shielded cables), as shown in **Figure 8-10**.

**Figure 8-10** Structure of a 120-ohm trunk cable

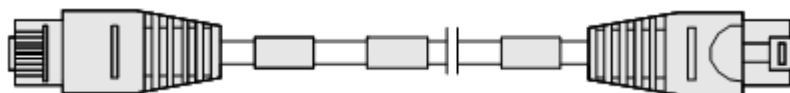


**NOTE**

To connect a switch to a clock source that has an RJ45 interface, use an RJ48 cable.

**RJ45 Cable**

RJ45 cables applicable to the switch are straight-through cables (shielded cables), as shown in [Figure 8-11](#).

**Figure 8-11** Structure of a straight-through cable**NOTE**

To connect a switch to a time source providing an RJ45 interface, use an RJ45 cable.

To connect a switch to a clock source that has a sub-miniature B (SMB) or bayonet-neill-concelman (BNC) interface, use an RJ45 cable and a transmultiplexer.

**SMB/SMB Trunk Cable**

An SMB/SMB trunk cable is a 75-ohm trunk cable with SMB connectors at both ends, as shown in [Figure 8-12](#).

**Figure 8-12** SMB/SMB trunk cable**SMB/BNC Trunk Cable**

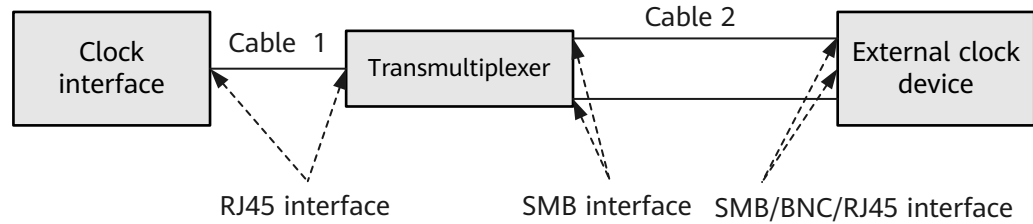
An SMB/BNC trunk cable is a 75-ohm trunk cable with an SMB connector at one end and a BNC connector at the other end, as shown in [Figure 8-13](#).

**Figure 8-13** SMB/BNC trunk cable**Connection**

One end of a clock cable is an RJ45 connector that is connected to the BITS interface on the Main Control Unit of the switch. The other end of the clock cable is connected to an external clock device. The connector type depends on the type of the external clock device. The external clock device can be a clock source that has an SMB, BNC, or RJ45 interface or a time source providing an RJ45 interface.



**Figure 8-14** Clock cable connections



Based on the functions and interface types of the external clock device connected to the switch, the following cables can be selected:

- When the connected device is a clock source with an RJ45 interface:  
Cable 1 can be an RJ48 cable. No transmultiplexer or cable 2 is required.
- When the connected device is a time source with an RJ45 interface:  
Cable 1 can be an RJ45 cable. No transmultiplexer or cable 2 is required.
- When the connected device is a clock source with an SMB interface:  
Cable 1 can be an RJ45 cable, and cable 2 can be an SMB/SMB trunk cable. A transmultiplexer is required.
- When the connected device is a clock source with a BNC interface:  
Cable 1 can be an RJ45 cable, and cable 2 can be an SMB/BNC trunk cable. A transmultiplexer is required.

## 8.6 Ethernet Cable

### Types of Ethernet Cables

An Ethernet cable connects a maintenance terminal to the console port on the device for local or remote maintenance.

Ethernet cables are classified into straight-through cables and crossover cables.

- Straight-through cable: The twisted pairs in the RJ45 connectors at both ends are crimped in the same sequence. A straight-through cable connects two devices of different types, for example, a PC and a switch.
- Crossover cable: The twisted pairs in the RJ45 connectors at two ends are crimped in different sequences. A crossover cable connects two devices or interfaces of the same type, for example, two PCs.

Crossover and straight cables only differ in wire sequences, and function the same when transmitting data.

Huawei switches support both straight-through and crossover cables and their ports are adaptive to the cable types.

Use shielded Ethernet cables when switches complying with EN 50121-4 are used in environments that meet EN 50121-4 requirements.

## Appearance and Structure

### NOTE

The straight-through cable and the crossover cable have the same appearance and use the RJ45 connector.

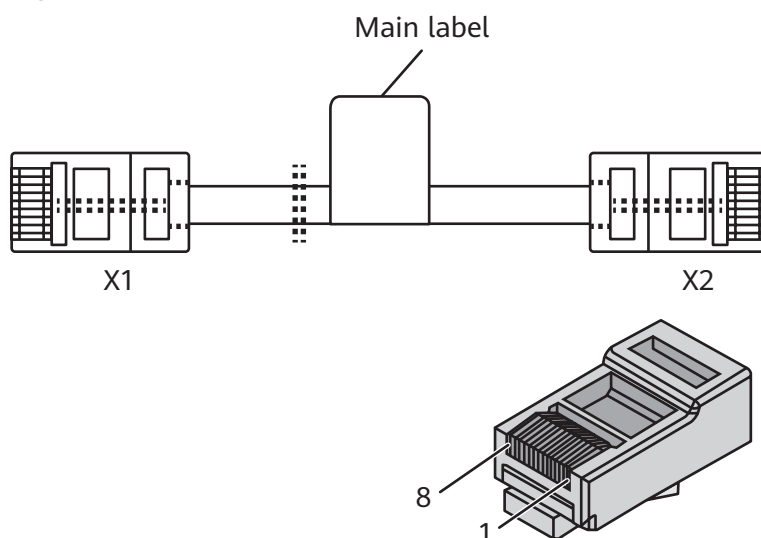
**Figure 8-15** shows the appearance of an Ethernet cable.

**Figure 8-15** Appearance of an Ethernet cable



**Figure 8-16** shows the structure of an Ethernet cable.

**Figure 8-16** Structure of an Ethernet cable



## Pin Assignments

**Table 8-4** lists pin assignments of a straight-through cable.

**Table 8-4** Pin assignments of a straight-through cable

Connector X1	Connector X2	Color	Relationship
X1.2	X2.2	Orange	Twisted pair
X1.1	X2.1	White/Orange	
X1.6	X2.6	Green	Twisted pair
X1.3	X2.3	White/Green	
X1.4	X2.4	Blue	Twisted pair
X1.5	X2.5	White/Blue	
X1.8	X2.8	Brown	Twisted pair
X1.7	X2.7	White/Brown	

**Table 8-5** lists pin assignments of a crossover cable.

**Table 8-5** Pin assignments of a crossover cable

Connector X1	Connector X2	Color	Relationship
X1.6	X2.2	Orange	Twisted pair
X1.3	X2.1	White/Orange	
X1.2	X2.6	Green	Twisted pair
X1.1	X2.3	White/Green	
X1.4	X2.4	Blue	Twisted pair
X1.5	X2.5	White/Blue	
X1.8	X2.8	Brown	Twisted pair
X1.7	X2.7	White/Brown	

### NOTE

To achieve the best electrical transmission performance, ensure that the wires connected to pins 1 and 2 and to pins 3 and 6 are twisted pairs.

## 8.7 High-Speed Cable

### Types of High-Speed Cable

**Table 8-6** describes different types of high-speed cables.

**Table 8-6** Types of high-speed cables

Cable Type		Model	Length	Electrical attribute	Bend Radius	Connector Type	Part number
SFP+ to SFP+ high-speed cable	1 m SFP+ high-speed cable	SFP-10G-CU1M	1 m	Passive	25 mm	SFP+ to SFP+	02310 MUN
	3 m SFP+ high-speed cable	SFP-10G-CU3M	3 m	Passive	25 mm	SFP+ to SFP+	02310 MUP
	5 m SFP+ high-speed cable	SFP-10G-CU5M	5 m	Passive	30 mm	SFP+ to SFP+	02310 QPR
	10 m SFP+ active high-speed cable	SFP-10G-AC10M	10 m	Active	25 mm	SFP+ to SFP+	02310 MUQ
QSFP+ to 4*SFP+ high-speed cable	1 m QSFP+ - 4*SFP+ high-speed cable	QSFP-4SFP 10G-CU1M	1 m	Passive	25 mm	QSFP+ to 4*SFP+	02310 MUK
	3 m QSFP+ - 4*SFP+ high-speed cable	QSFP-4SFP 10G-CU3M	3 m	Passive	25 mm	QSFP+ to 4*SFP+	02310 MUL

Cable Type		Model	Length	Electrical attribute	Bend Radius	Connector Type	Part number
	5 m QSFP+ - 4*SFP+ high-speed cable	QSFP-4SFP 10G-CU5M	5 m	Passive	30 mm	QSFP+ to 4*SFP+	02310 MUM
QSFP+ to QSFP+ high-speed cable	1 m QSFP+ - QSFP+ high-speed cable	QSFP-40G-CU1M	1 m	Passive	35 mm	QSFP+ to QSFP+	02310 MUG
	3 m QSFP+ - QSFP+ high-speed cable	QSFP-40G-CU3M	3 m	Passive	40 mm	QSFP+ to QSFP+	02310 MUH
	5 m QSFP+ - QSFP+ high-speed cable	QSFP-40G-CU5M	5 m	Passive	45 mm	QSFP+ to QSFP+	02310 MUJ
QSFP28 to QSFP28 high-speed cable	1 m QSFP28 - QSFP28 high-speed cable	QSFP28-10 0G-CU1M	1 m	Passive	70 mm	QSFP28 to QSFP28	02311 KNW
	3 m QSFP28 - QSFP28 high-speed cable	QSFP28-10 0G-CU3M	3 m	Passive	70 mm	QSFP28 to QSFP28	02311 KNX
	5 m QSFP28 - QSFP28 high-speed cable	QSFP28-10 0G-CU5M	5 m	Passive	70 mm	QSFP28 to QSFP28	02311 KNY

**NOTICE**

Do not reversely insert the QSFP+ cable plugs. The side with an L-shaped groove is the top of a QSFP+ cable plug, as shown in [Figure 8-17](#). Keep the top side down when inserting the QSFP+ cable plug to a port on a CSS card. Keep the top side up when inserting the QSFP+ cable plug into another port.

Both ends of a QSFP+ high-speed cable must be covered by ESD caps.

If a port of an S series modular switch uses a high-speed copper cable, the port can only be connected to another S series modular switch.

**Figure 8-17** QSFP+ cable plug



## Appearance and Structure

[Figure 8-18](#) shows an SFP+ to SFP+ high-speed cable.

**Figure 8-18** SFP+ to SFP+ high-speed cable



[Figure 8-19](#) shows a QSFP+ to QSFP+ and QSFP28 to QSFP28 high-speed cable.

**Figure 8-19** QSFP+ to QSFP+ and QSFP28 to QSFP28 high-speed cable



[Figure 8-20](#) shows a QSFP+ to 4\*SFP+ high-speed cable.

**Figure 8-20** QSFP+ to 4\*SFP+ high-speed cable



**Figure 8-21** shows the structure of an SFP+ to SFP+ high-speed cable.

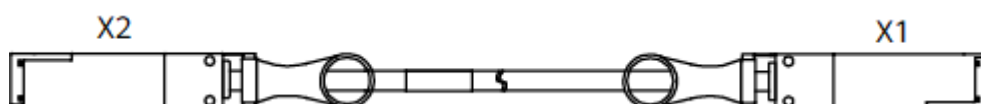
**Figure 8-21** Structure of an SFP+ to SFP+ high-speed cable



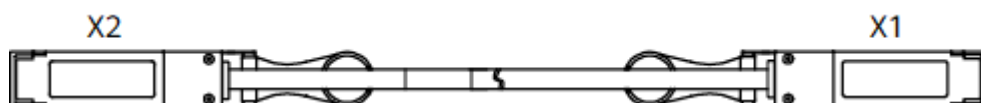
**Figure 8-22** shows the structure of a QSFP+ to QSFP+ and QSFP28 to QSFP28 high-speed cable.

**Figure 8-22** Structure of a QSFP+ to QSFP+ and QSFP28 to QSFP28 high-speed cable

Front view:

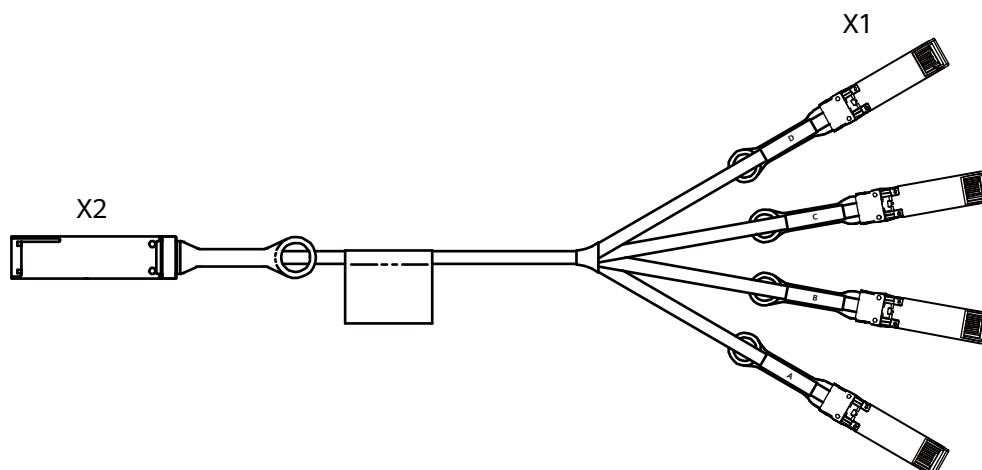


Rear view:



**Figure 8-23** shows the structure of a QSFP+ to 4\*SFP+ high-speed cable.

**Figure 8-23** Structure of a QSFP+ to 4\*SFP+ high-speed cable

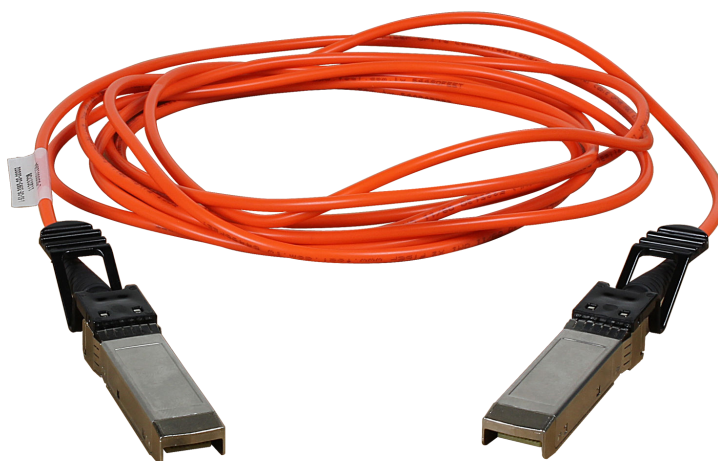


## 8.8 Optical Fiber

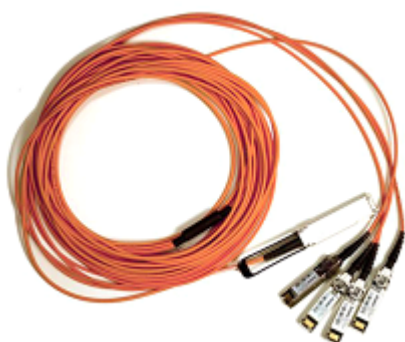
### Active Optical Cable

An active optical cable (AOC) is an optical fiber with optical modules at both ends, making it easy to use.

**Figure 8-24** SFP+ to SFP+ AOC cable





**Figure 8-25** QSFP+ to QSFP+ or QSFP28 to QSFP28 AOC cable**Figure 8-26** QSFP+ to 4\*SFP+ AOC cable

**Table 8-7** lists the models and attributes of AOC cables.

**Table 8-7** Attributes of AOC cables

Model	Length	Bend Radius	Connector Type	Part Number	Operating Temperature
SFP-10G-AOC3M	3 m	30 mm	SFP+ connectors at both ends	02310QWG	0°C to 70°C
SFP-10G-AOC10M	10 m	30 mm	SFP+ connectors at both ends	02310QWH	0°C to 70°C
QSFP-H40G-AOC10M	10 m	25 mm	QSFP+ connectors at both ends	02310SSH	0°C to 70°C
QSFP-4SFP10-AOC10M	10 m	25 mm	QSFP+ connector at one end and four SFP+ connectors at the other end	02310SSJ	0°C to 70°C
QSFP-100G-AOC-10M	10 m	25 mm	QSFP28 connectors at both ends	02311KNQ	0°C to 70°C

## Fiber Jumper

A fiber jumper consists of one or more fibers of a certain length and the optical connectors at both ends. A fiber jumper connects an optical module to a fiber terminal box.

### NOTE

- The MPO-MPO and MPO-2\*MPO fibers have similar appearances except for the number of MPO connectors at the other end. The following figures show an MPO-MPO fiber for example.
- The MPO-4\*DLC and MPO-10\*DLC fibers have similar appearances except for the number of DLC connectors at the other end.
- The MPO-MPO fibers for S series switches use type B connectors (key Up/key Up).

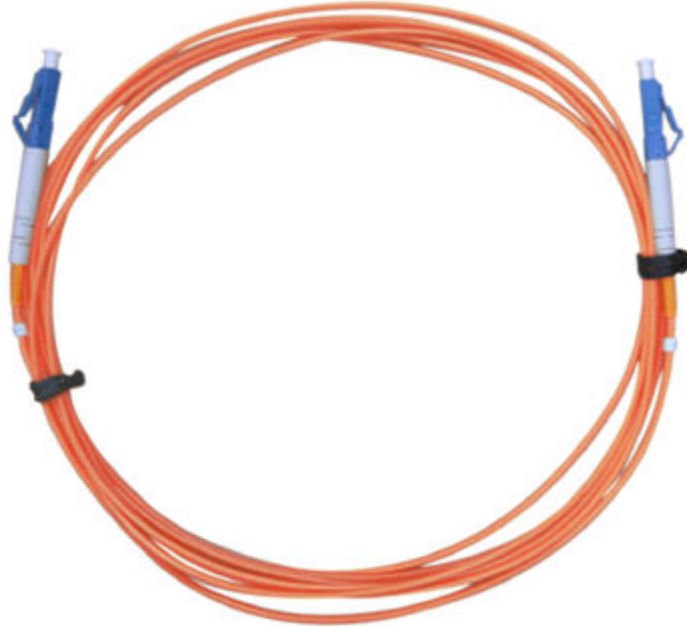
**Figure 8-27** shows a single-mode LC/PC fiber jumper.

**Figure 8-27** Single-mode LC/PC fiber jumper



**Figure 8-28** shows a multimode LC/PC fiber jumper.

**Figure 8-28** Multimode LC/PC fiber jumper



**Figure 8-29** shows a single-mode SC/PC fiber jumper.

**Figure 8-29** Single-mode SC/PC fiber jumper



**Figure 8-30** shows an MPO-MPO fiber jumper.

**Figure 8-30** MPO-MPO fiber jumper



**Figure 8-31** shows an MPO-4\*DLC fiber jumper.

**Figure 8-31** MPO-4\*DLC fiber jumper



**Figure 8-32** shows an MPO-10\*DLC fiber jumper.

**Figure 8-32** MPO-10\*DLC fiber jumper

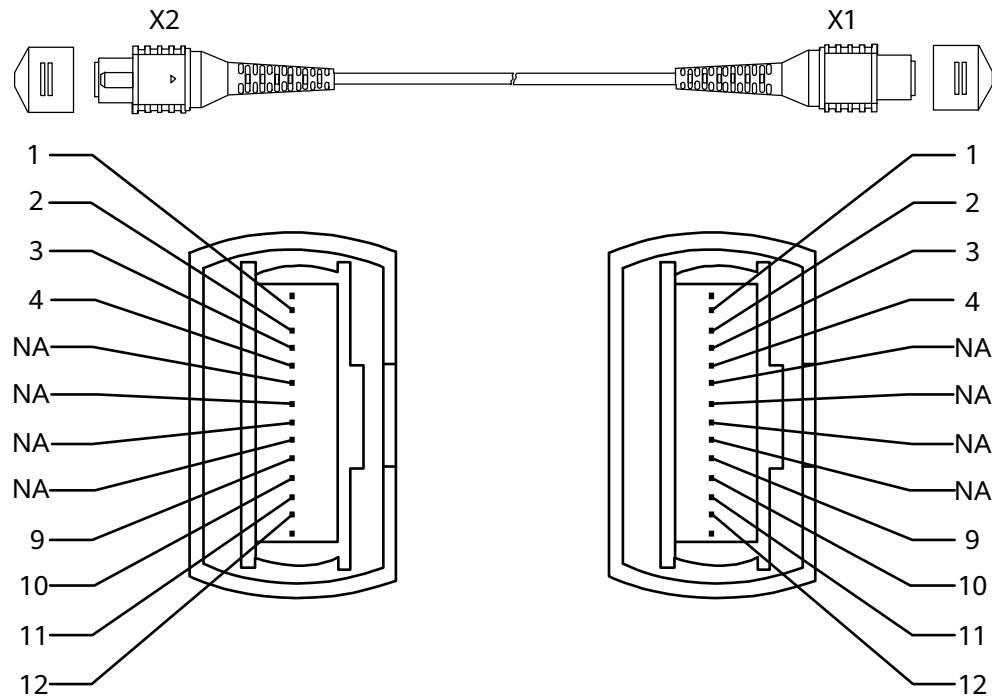


Comply with the following rules when selecting fiber jumpers:

1. Determine the length of fiber jumpers based on the onsite cabling distance.
2. Determine the fiber type based on the optical module type.
  - Use a multimode fiber jumper for a multimode optical module.
  - Use a single-mode fiber jumper for a single-mode optical module.
3. Determine the optical connector type based on the interface type.  
Ensure that the optical connector at each end of a fiber jumper is the same type as the interface to which it will be connected.

**Figure 8-33** shows the structure of an 8-strand MPO-MPO fiber jumper.

**Figure 8-33** Structure of an 8-strand MPO-MPO fiber jumper



**Figure 8-34** shows the structure of a 12-strand MPO-MPO fiber jumper.

**Figure 8-34** Structure of a 12-strand MPO-MPO fiber jumper

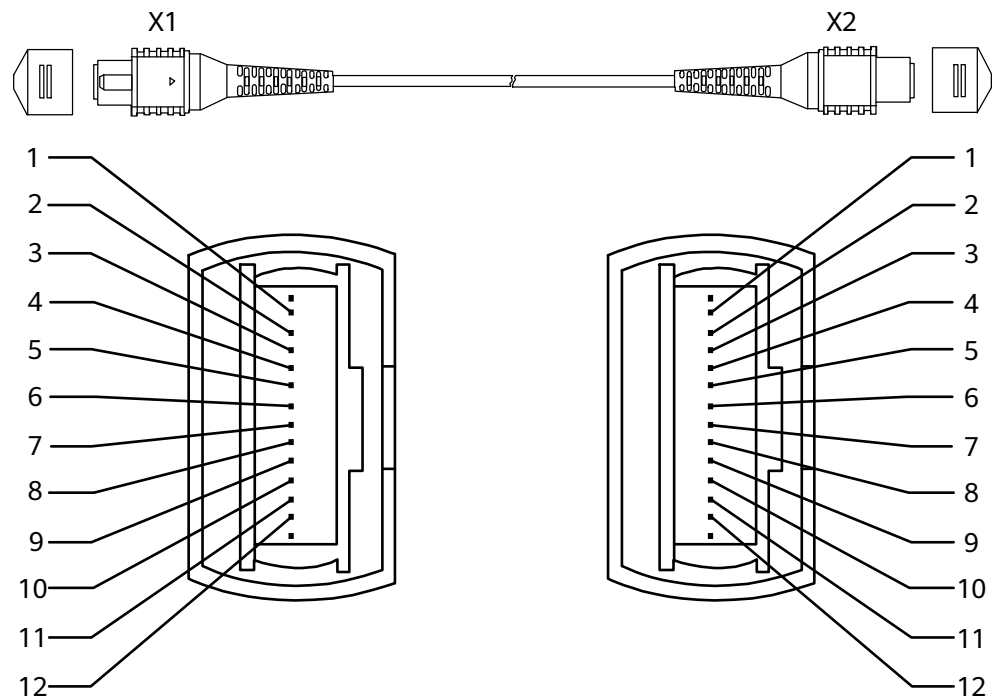


Figure 8-35 shows the structure of a 24-strand MPO-MPO fiber jumper.

Figure 8-35 Structure of a 24-strand MPO-MPO fiber jumper

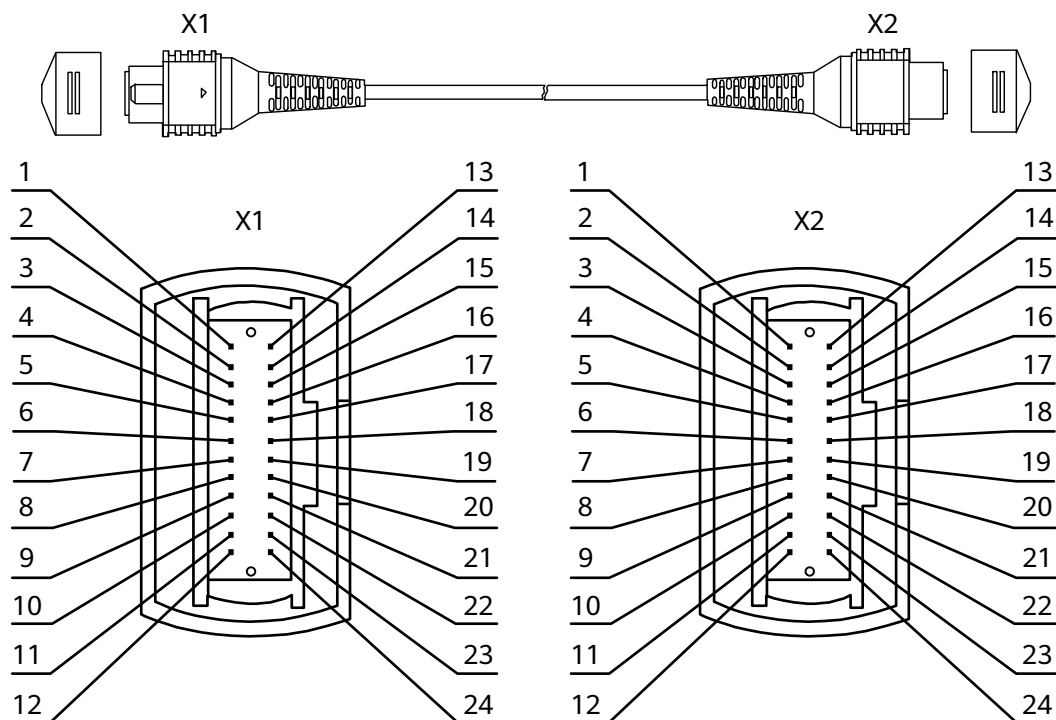
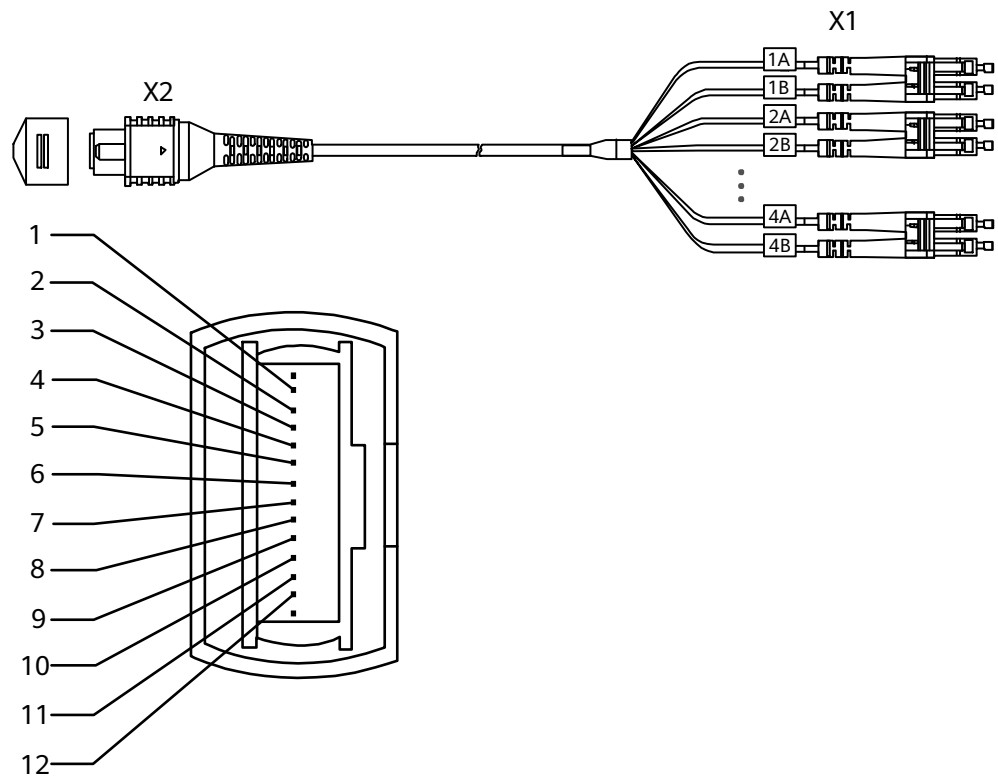


Figure 8-36 shows the structure of an MPO-4\*DLC fiber jumper.

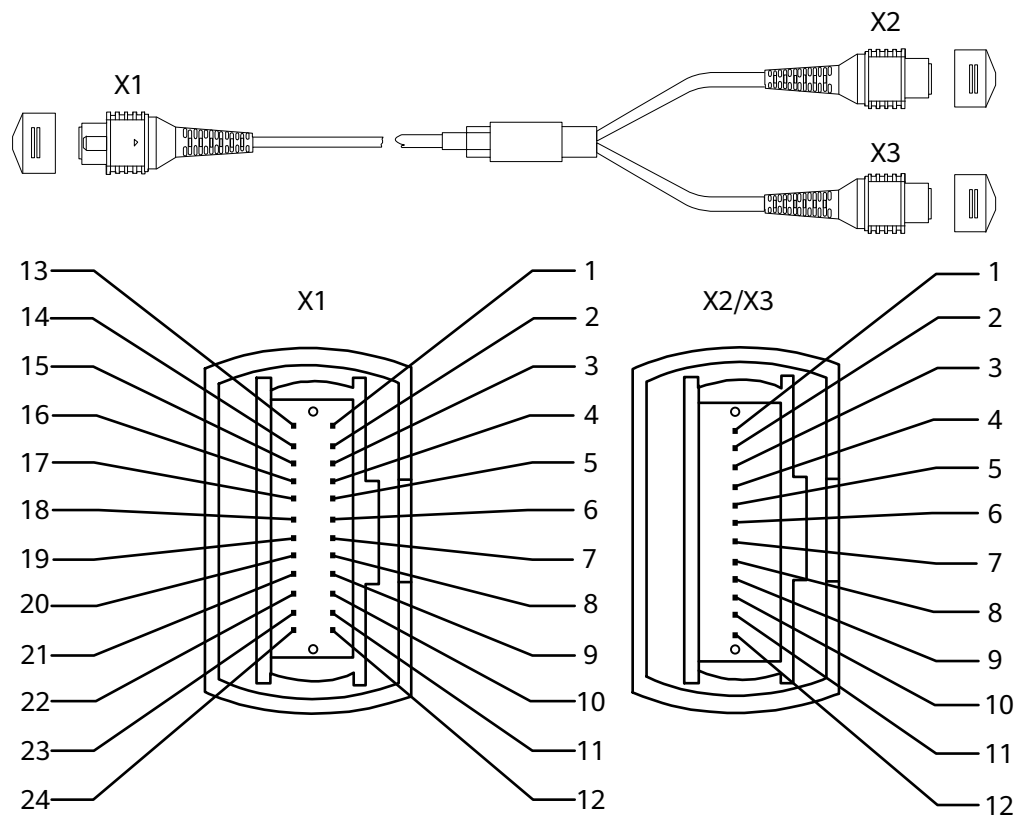
**Figure 8-36** Structure of an MPO-4\*DLC fiber jumper



**Figure 8-37** shows the structure of an MPO-2\*MPO fiber jumper.

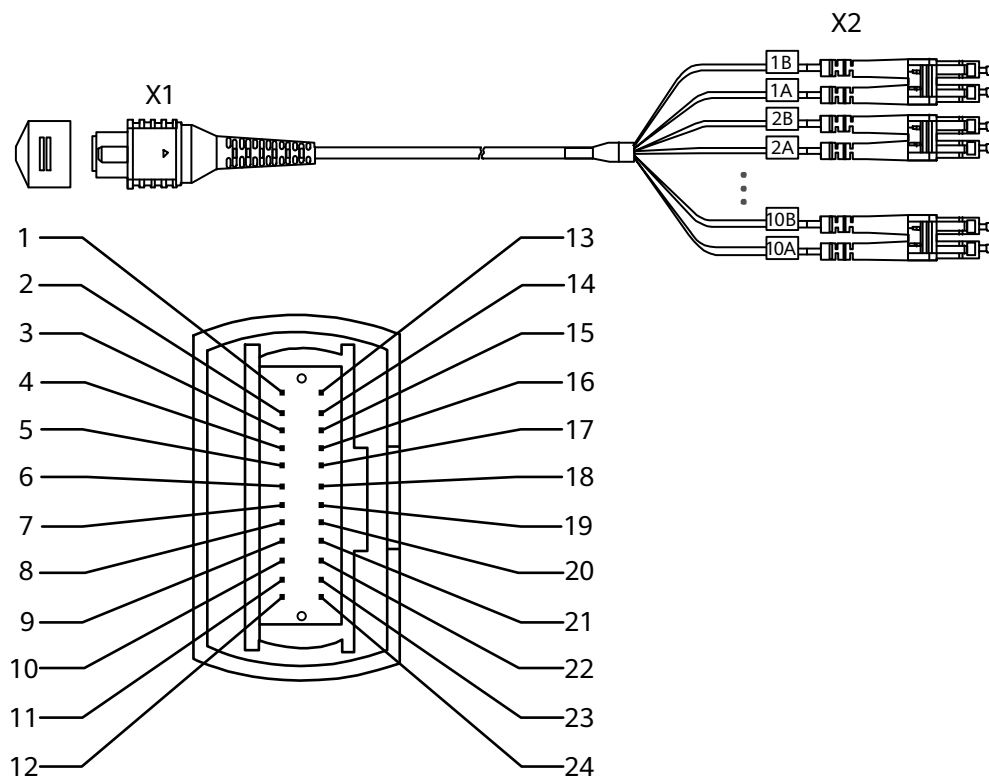


**Figure 8-37** Structure of an MPO-2\*MPO fiber jumper



**Figure 8-38** shows the structure of an MPO-10\*DLC fiber jumper.

**Figure 8-38** Structure of an MPO-10\*DLC fiber jumper



**Table 8-8** lists the pin assignments of an 8-strand MPO-MPO fiber jumper.

**Table 8-8** Pin assignments of an 8-strand MPO-MPO fiber jumper

X1 Pin	X2 Pin
1	12
2	11
3	10
4	9
NA	NA
NA	NA
NA	NA
NA	NA
9	4
10	3
11	2

X1 Pin	X2 Pin
12	1

**Table 8-9** lists the pin assignments of a 12-strand MPO-MPO fiber jumper.

**Table 8-9** Pin assignments of a 12-strand MPO-MPO fiber jumper

X1 Pin	X2 Pin
1	12
2	11
3	10
4	9
5	8
6	7
7	6
8	5
9	4
10	3
11	2
12	1

**Table 8-10** lists the pin assignments of a 24-strand MPO-MPO fiber jumper.

**Table 8-10** Pin assignments of a 24-strand MPO-MPO fiber jumper

X1 Pin	X2 Pin	X1 Pin	X2 Pin
1	24	13	12
2	23	14	11
3	22	15	10
4	21	16	9
5	20	17	8
6	19	18	7
7	18	19	6

X1 Pin	X2 Pin	X1 Pin	X2 Pin
8	17	20	5
9	16	21	4
10	15	22	3
11	14	23	2
12	13	24	1

**Table 8-11** lists the pin assignments of an MPO-4\*DLC fiber jumper.

**Table 8-11** Pin assignments of an MPO-4\*DLC fiber jumper

X2 Pin	X1 Pin
1	1A
2	2A
3	3A
4	4A
9	4B
10	3B
11	2B
12	1B

**Table 8-12** lists the pin assignments of an MPO-2\*MPO fiber jumper.

**Table 8-12** Pin assignments of an MPO-2\*MPO fiber jumper

X1 Pin	X2 Pin	X3 Pin
2	12	NA
3	11	NA
4	10	NA
5	9	NA
7	NA	12
8	NA	11
9	NA	10

X1 Pin	X2 Pin	X3 Pin
10	NA	9
14	1	NA
15	2	NA
16	3	NA
17	4	NA
19	NA	1
20	NA	2
21	NA	3
22	NA	4

**Table 8-13** lists the pin assignments of an MPO-10\*DLC fiber jumper.

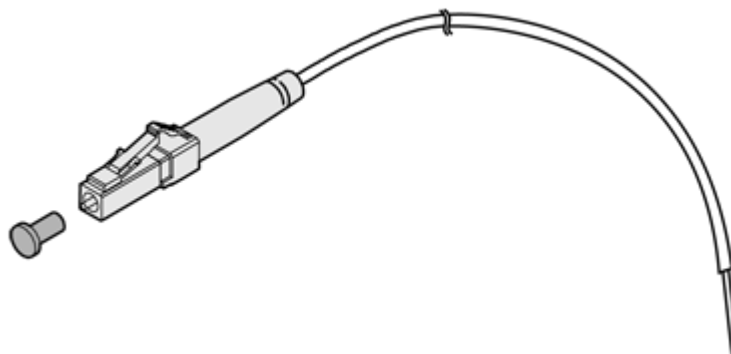
**Table 8-13** Pin assignments of an MPO-10\*DLC fiber jumper

X1 Pin	X2 Pin	X1 Pin	X2 Pin
2	1A	14	1B
3	2A	15	2B
4	3A	16	3B
5	4A	17	4B
6	5A	18	5B
7	6A	19	6B
8	7A	20	7B
9	8A	21	8B
10	9A	22	9B
11	10A	23	10B

## Fiber Pigtail

A fiber pigtail is an optical fiber that has an optical connector on one end and a piece of exposed fiber at the other end. The exposed fiber can be fused to another optical fiber. Fiber pigtails are commonly used to connect optical fibers to optical modules in fiber terminal boxes (couplers and jumpers are also used). **Figure 8-39** shows the structure of a fiber pigtail.

**Figure 8-39** Structure of a fiber pigtail



Fiber pigtails are classified into single-mode and multimode fiber pigtails and are used for short-distance connections.

## Optical Fiber, Optical Connector, and Fiber Adapter

### Optical Fibers

Optical fibers are classified into single-mode fibers and multimode fibers.

- Single-mode fibers have a diameter of 5-10  $\mu\text{m}$  and transmit laser in one mode under a specified wavelength. These fibers support a wide frequency band and a large transmission capacity, so they are used for long-distance transmission. Most single-mode fibers are yellow, as shown in [Figure 8-27](#).
- Multimode fibers have a diameter of 50  $\mu\text{m}$  or 62.5  $\mu\text{m}$  and transmit laser light in multiple modes under a specified wavelength. These fibers have a lower transmission capacity than single-mode fibers and are used for short-distance transmission. Modal dispersion occurs during transmission over multimode fibers.

In the latest cabling infrastructure of ISO/IEC 11801, multimode fibers are classified into four categories: OM1, OM2, OM3, and OM4.

- OM1: traditional 62.5/125  $\mu\text{m}$  multimode fibers. OM1 fibers have a large core diameter and numerical aperture, and provide high light gathering ability and bending resistance.
- OM2: traditional 50/125  $\mu\text{m}$  multimode fibers. OM2 fibers have a small core diameter and numerical aperture. Compared with OM1 fibers, OM2 fibers provide higher bandwidth because they significantly reduce the modal dispersion. When transmitting data at 1 Gbit/s with 850 nm wavelength, OM1 and OM2 fibers support maximum link lengths of 220 m and 550 m, respectively. OM1 and OM2 fibers can provide sufficient bandwidth within a distance of 300 m. Generally, OM1 and OM2 fibers are orange, as shown in [Figure 8-28](#).
- OM3: new-generation multimode fibers, with longer transmission distances than OM1 and OM2 fibers.
- OM4: laser optimized multimode fibers with 50  $\mu\text{m}$  core diameter. OM4 is an improvement to OM3 and only increases the modal bandwidth. OM4 fibers provide 4700 MHz\*km of modal bandwidth, whereas OM3 fibers provide only 2000 MHz\*km of modal bandwidth. Generally, OM3

and OM4 fibers are light green. You can identify OM3 and OM4 fibers by their labels or printed marks.







MPO fibers are used for 40G and 100G optical modules. An MPO fiber consists of multiple multi-mode fiber strands, and each multi-mode fiber strand provides one laser transmission channel. Some fiber suppliers produce 8-strand MPO optical fibers, while some suppliers produce 12-strand or 24-strand MPO fibers.

- A 40G optical module uses four channels to transmit laser and four channels to receive laser. That is, a total of eight channels are required for a 40G optical module. 8-strand and 12-strand MPO fibers use the same definition of fiber channels. Therefore, they are equivalent in functionality when connecting to 40G optical modules.
- When 100G optical modules are used, choose MPO fibers according to the following rules:
  - For CFP optical modules, choose 24-strand fibers for the CFP-100G-SR10 module and 8-strand or 12-strand fibers for other modules.
  - Choose 8-strand or 12-strand fibers for QSFP28 modules.

### Optical Connector

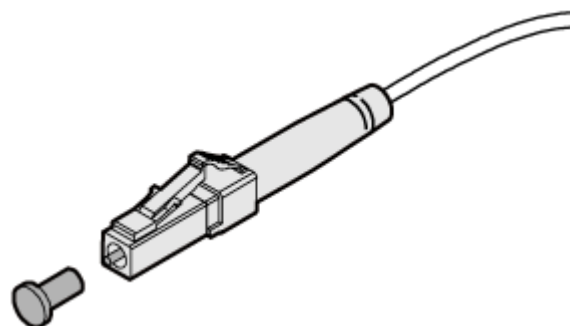
Optical connectors are used to connect optical fibers of the same type. [Table 8-14](#) lists common optical connectors.

**Table 8-14** Common optical connectors

Connect or Type	Optical Connector			
Square connector	SC/PC connector 	LC/PC connector 	MTRJ/PC connector 	MPO connector 
Round connector	FC/PC connector 	ST/PC connector 	-	-

[Figure 8-40](#) shows an LC/PC optical connector.

**Figure 8-40** LC/PC optical connector



---

**NOTICE**

When connecting or removing an LC/PC optical connector, align the connector with the optical port and do not rotate the fiber. Pay attention to the following points:

- To connect a fiber, align the optical connector with the optical port and gently insert the optical fiber into the port.
- To remove a fiber, press the clip on the connector and pull the fiber out.

---

**Fiber Adapter**

A fiber adapter (also called a flange) is a fiber connection component. Two fiber connectors need to be connected using a fiber adapter. Fiber adapters are widely used in optical distribution frames (ODFs), fiber transmission equipment, and optical instruments.